

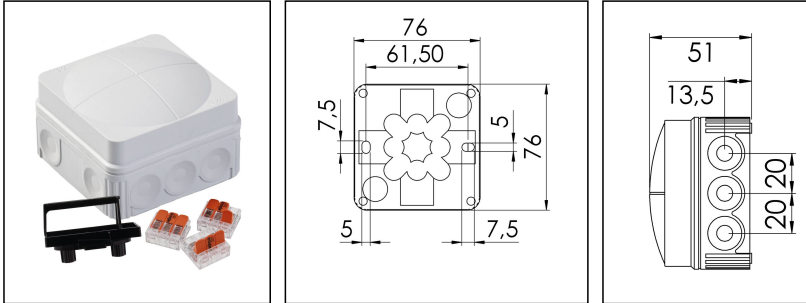

COMBI 108 LG / 3-221-413



Products may differ in size, colour and appearance to those shown. If you require further information or customisation, please contact us directly.



Material	Polypropylene
Material sealing gasket	TPE
Temp. range min	-30 °C
Temp. range max	100 °C
Temperatures during install.	-5 °C - 60 °C
Protection class	IP66
Glow wire test	750 °C
Voltage	400 V
Rated cross section	2,5 mm ²
Fixing	2 internal openings
Ø cable diameter min	3 mm
Ø cable diameter max	14 mm
External dimensions LxWxH	76 x 76 x 51mm
Using for cable gland	
Product Color	RAL 7035
WISKA-Order no.	10111272
Type	COMBI 108 LG / 3-221-413
Packing unit	10
EAN number	4007686277265
Tariff number	85369010
ETIM-Classification	EC002600

Remarks:

Equipment:

- 10 elastic self-sealing puncture-membranes for cable entry on the side and 2 in the bottom

Your Contact:

WISKA UK Ltd.

Unit 7, Hurling Way · St. Columb Major Business Park · TR9 6SX, St. Columb Major, Cornwall · Great Britain

☎ +44-12-08816062 · 📠 +44-12-08816708

info@wiska.co.uk · www.wiska.co.uk

- including terminal carrier on quick mounting plate mounted +
3x WAGO 221-413 enclosed loose

Fixing:



By two internal openings outside of the sealing area

25.10.2023

Your Contact:

WISKA UK Ltd.

Unit 7, Hurling Way · St. Columb Major Business Park · TR9 6SX, St. Columb Major, Cornwall · Great Britain

 +44-12-08816062 ·  +44-12-08816708

info@wiska.co.uk · www.wiska.co.uk

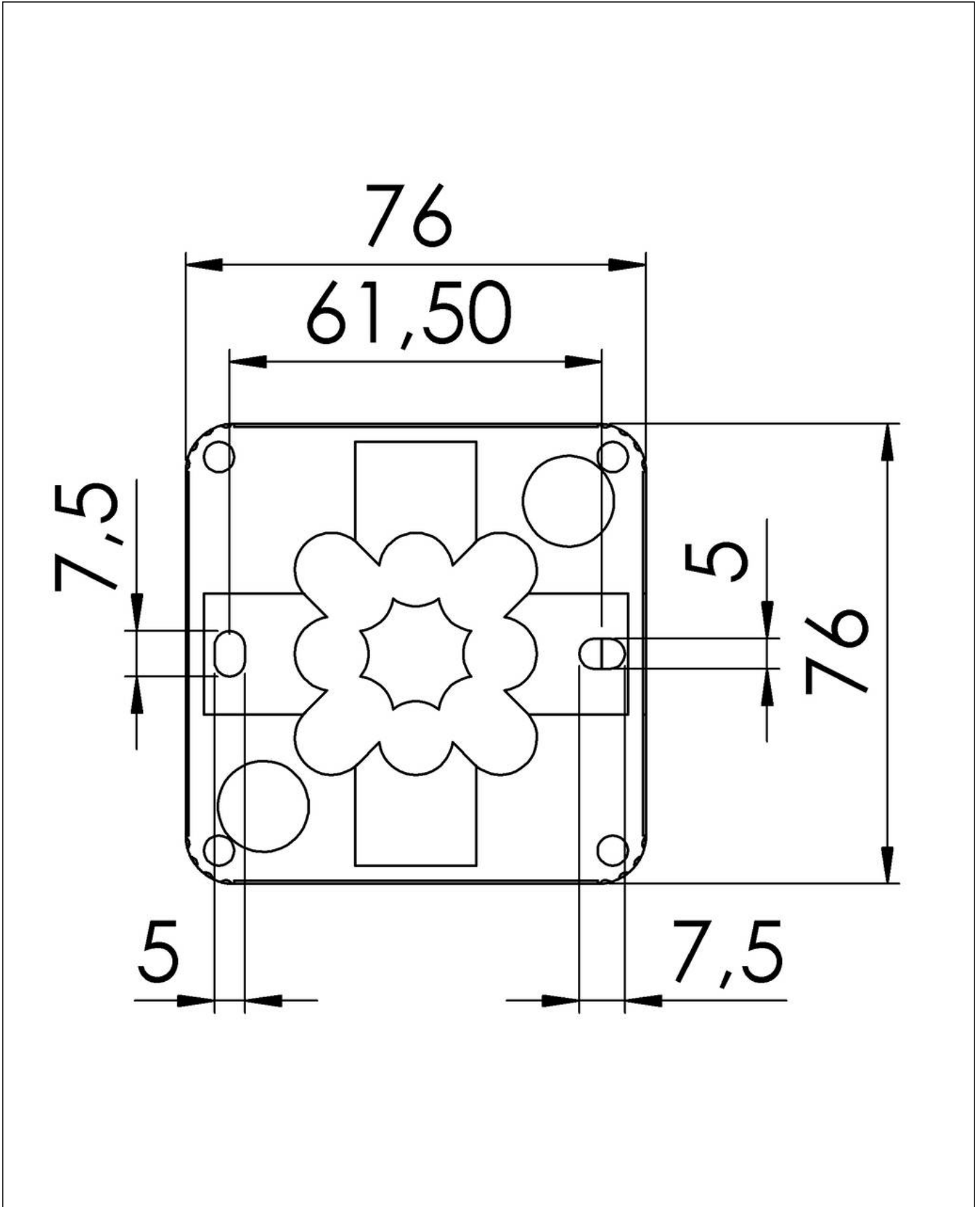

Your Contact:

WISKA UK Ltd.

Unit 7, Hurling Way · St. Columb Major Business Park · TR9 6SX, St. Columb Major, Cornwall · Great Britain

☎ +44-12-08816062 · 📠 +44-12-08816708

info@wiska.co.uk · www.wiska.co.uk

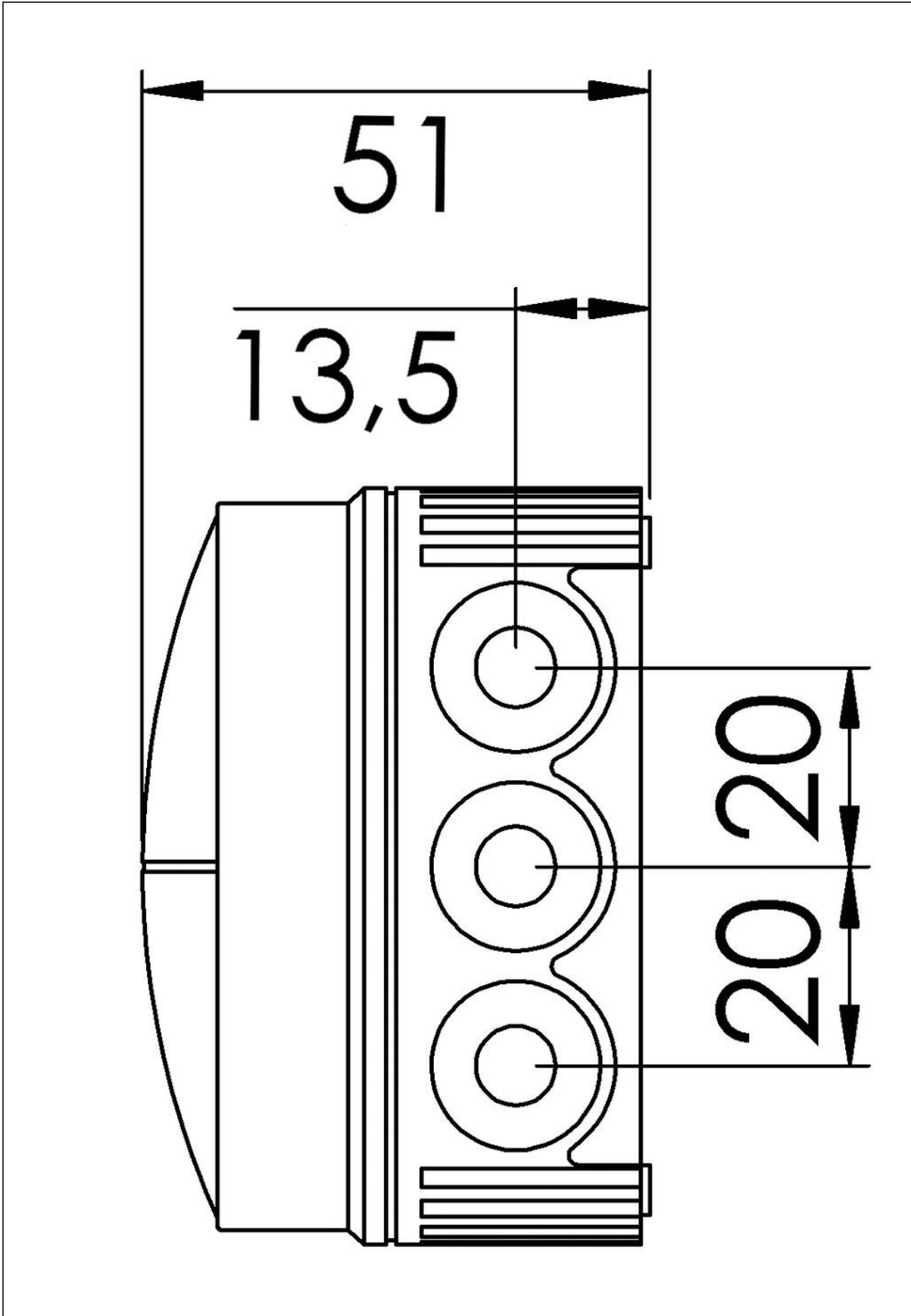

Your Contact:

WISKA UK Ltd.

Unit 7, Hurling Way · St. Columb Major Business Park · TR9 6SX, St. Columb Major, Cornwall · Great Britain

☎ +44-12-08816062 · 📠 +44-12-08816708

info@wiska.co.uk · www.wiska.co.uk